



NEW

German quality: high security, sound and thermal insulation



Steel Top Security Door

The best choice for your home



Enjoy your home

The best security door with proven Hörmann quality



Hörmann's steel top security doors are available in a wide selection of styles. Thanks to high quality imported multi-point locking systems, these doors give you a feeling of security. The excellent infill material used for the door leaf and the unique sealing design between door leaf and frame mean that sound and thermal insulation are guaranteed to a high level.



Hörmann products are manufactured strictly according to the Chinese Quality Management System GB/T 19001-2008/ISO9001:2008 and have been certified under ISO14001:2004 Environmental Management System.

The Best Burglar Resistance

Because you and your family want to feel safe at home, Hörmann top security doors are equipped with multi-point locking as standard for extra security. The single-leaf door is trusted by 14 locking points, as 21 locking points for the double-leaf door giving you a reassuring feeling.



Certified Grade A burglar resistance, in accordance with Chinese Standard GB 17565-2007.

Certified RC 3 burglar resistance, in accordance with DIN EN 1627:2011.



Good Fire Retardancy

The infill of the door leaf is made of a sandwich-structure consisting of mineral wool + fireproof board + mineral wool. The custom-built infill structure, especially developed for the top security doors, provides efficient fire resistance combined with thermal and sound insulation.



Certified 30 minutes fire retardancy according to DIN 4102 T5 and EN 1634-1, test result is T30 and EL₂30.

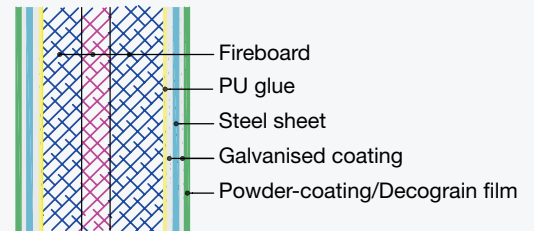

High Thermal Insulation

Nowadays, people are trying to save energy throughout their homes. Thanks to a 100 mm thick door leaf completely filled with high quality fire insulation material, these doors provide excellent thermal insulation, reducing your energy bills!



Thermal Insulation value reach up to 1.7W/(M²·K), according to GB/T 8484-2008.

Thermal Insulation value reach up to 2.0 W/(M²·K), according to EN ISO 12567-1:2010.

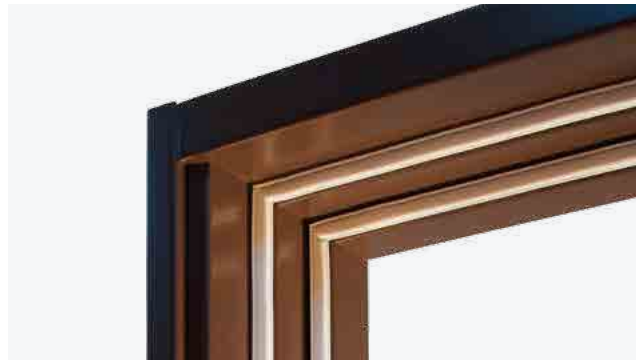

Excellent Sealing

Double sealing on all four sides with an additional threshold provides extra protection against bad weather. Heat loss and noise are reduced.



Sound Insulation reach up to 38 dB, according to GB/T 8485-2008.

Sound Insulation reach up to 38 dB, according to EN ISO 717-1:1996 + A1:2006.



Air Permability of Class 2, according to EN 12207:1999-11.

Wind Pressure Resistance of Class C5/B5 (highest level), according to EN 12210:1999-11 / AC:2002-08.



Safety is No. 1 for your home



Hörmann top security door is your most reliable safeguard. The imported locking system with patent pending keep the uninvited guests away. With the personal registration card, you can leave your worries behind.



All Hörmann security doors meet the Chinese National Standard GB 17565-2007 and are marked on their hinge frame inner side accordingly.

Certified by GB 17565-2007 Grade A Burglar Resistance



Security lock

Hörmann top security doors comply with the highest Standard of Mechanical Security Locks GA/T73-94. The multiple bolt locking with its design incorporating high-precision transmission gearing ensures smooth and effortless turning.

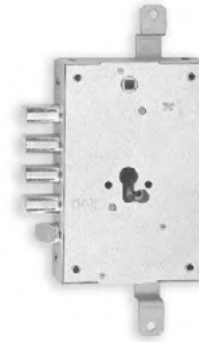

Security cylinder

(Key combination > 220,000,000)

- 11 pins and 3 side pins are made of stainless steel
- 3 anti-drill protectors on the cylinder body and barrel
- Patented reversible keys made of nickel silver
- Registration card
- High security level key with protective cap in sealed package

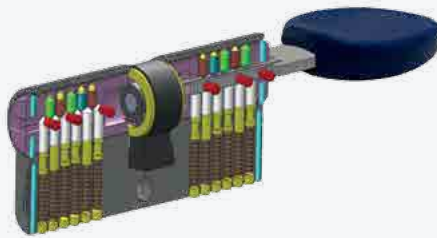

Reinforced structure

Both sides of the main and subsidiary lock body and hinge are protected by 3 mm thick anti-drilling steel sheets. The steel reinforced bar mesh, spaced at about 200 mm, is combined with the U-shaped steel tube in four sides of the door leaf, to guarantee that the door leaf has high stability in order to resist damage and impact.

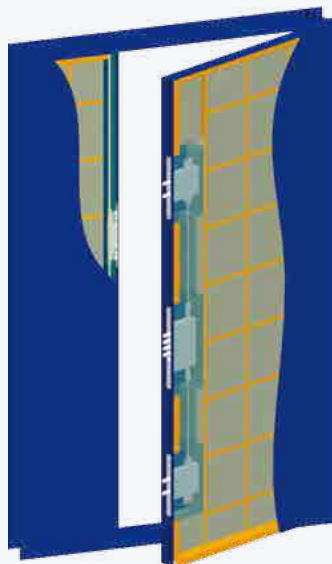

Door Fittings

Locking points

Imported multiple bolt locking systems meet your higher demand for safety. There are 14 locking points for a single leaf door and 21 locking points for a double leaf door. The door leaf with 9 locking bolts sized 18-20 mm and an additional two 16mm safety bolts on the hinge side are tightly fixed to the door frame. It is impossible to detach the door leaf by force.

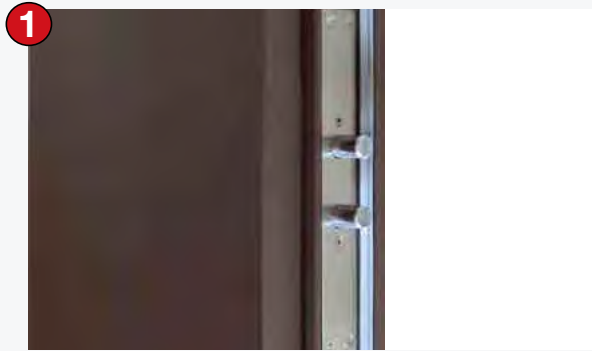

Side locking bolts



Main locking bolts



Safety bolt

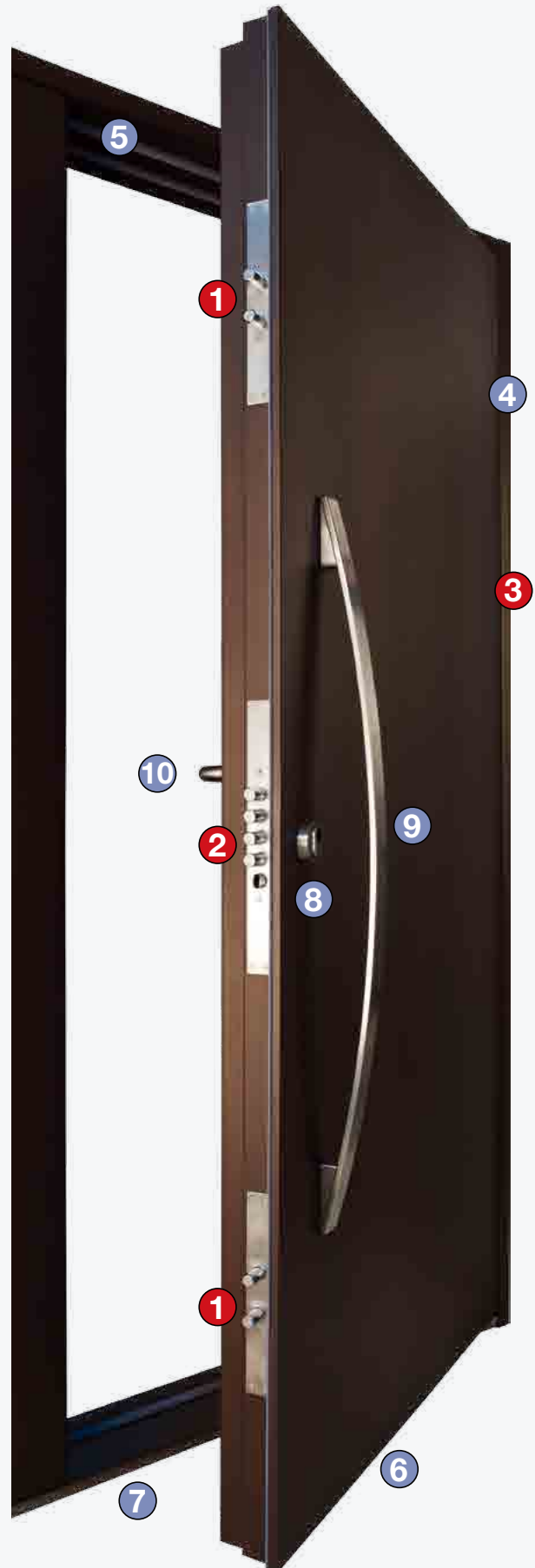



4 **Concealed hinge**

Imported 3-dimension adjustable hinge is durable, flexible and safe.

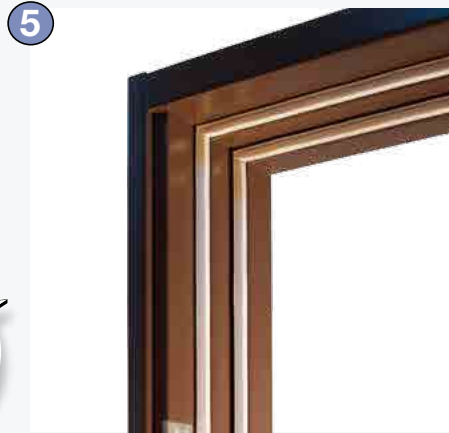

5 **Double sealing of frame**

The embedded sealing on four sides of the frame guarantees better thermal and sound insulation.



6 **Retractable bottom seal**

To provide the perfect seal when the door is fully closed.

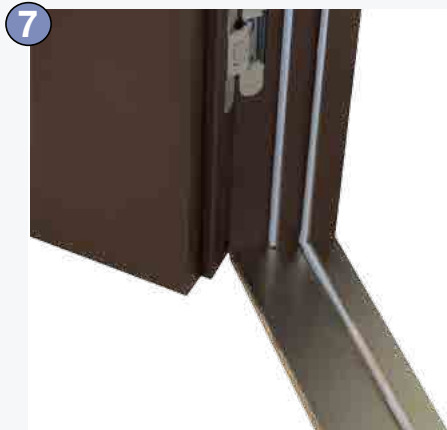

7 **Threshold**

Sturdy, made of stainless steel.



8 **Anti-drill protection**

Cast in stainless steel, a practical guard for the cylinder.



Patented key

Patented key with pins to avoid unauthorised key duplication.



9 **Exterior handle**

Various choices of handle make your home unique.

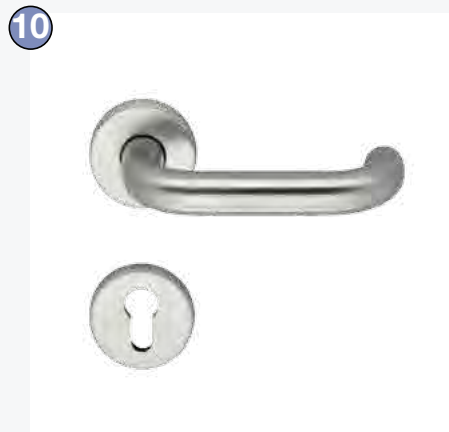

10 **Interior handle**

Various options for the material and shape of the handle.

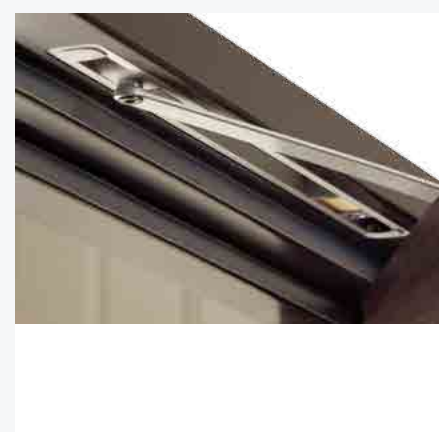

Concealed door closer (optional)

To guarantee the smooth and quiet closing of the door leaf.

Individual Design of Handles



HOE 760 Series

Decograin embellishment

Handle in aluminium EV1: handle embellishment is available in White Ash, Grey Ash, French Oak, Mahogany, Italian Cherry, Dark Mahogany, Sandalwood, Linea Tabac and Horizontal Oak Dark.



Dark Mahogany



Mahogany



French Oak

Colourful embellishment

Handle in aluminium EV1: handle embellishment is available based on the RAL colour chart.



RAL 9016 Traffic white



RAL 3003 Ruby red



CH 703 Dark grey



HOE 100
Satin stainless steel
(standard)



HOE 300
Satin stainless steel



HOE 600
Satin stainless steel

A question of taste: Select your favourite colour



You can select according to your taste — whether you want classic white, one of your favourite colours or a Decograin surface. Pick the colour that fits your home best!

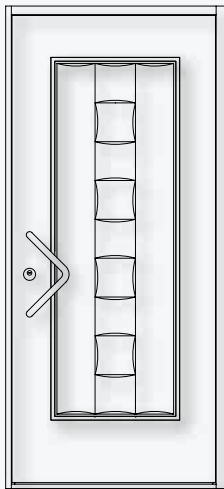

Kingly

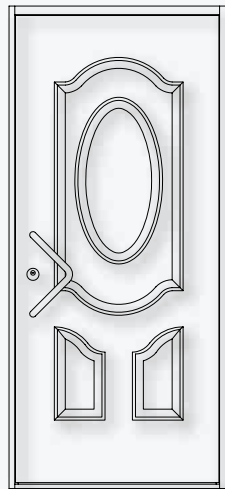

Europa Round 3

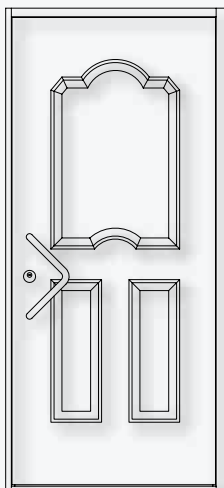

Europa Vertical 3

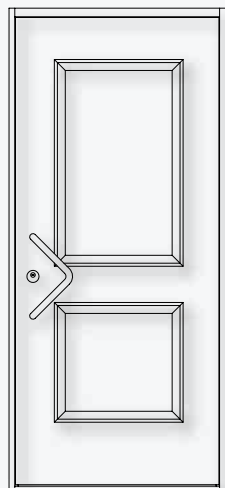

Basic 2

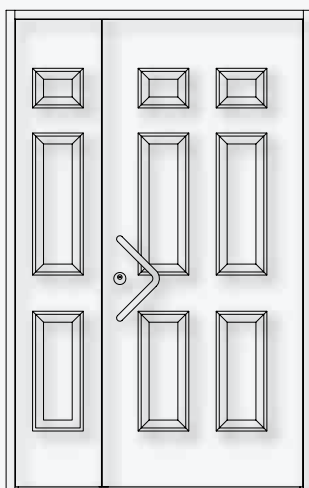

Basic 6

Powder coating surface

The smooth appearance provided by the advanced powder coating line presents the steel doors in the best way. You may choose from a spectrum of colours based on the RAL chart to suit your taste.



Decograin surface

The top quality Decograin film is perfectly attached to the galvanised steel sheet of the door leaf through an advanced heat pressing procedure. Not only do the foil-coated timber designs have a natural-looking appearance, but they are also UV resistant, highly durable and easy to maintain.

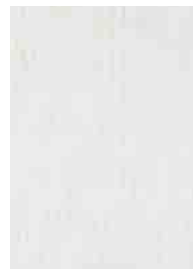

White Ash



Grey Ash



French Oak



Italian Cherry



Mahogany



Dark Mahogany



Linea Tabac



Dark Sandalwood



Horizontal Oak Dark

The colours and surface finishes illustrated are subject to the limitations of the printing process.

Better life as always

A range of Hörmann products bring you the same level of comfort



Technical data and size range

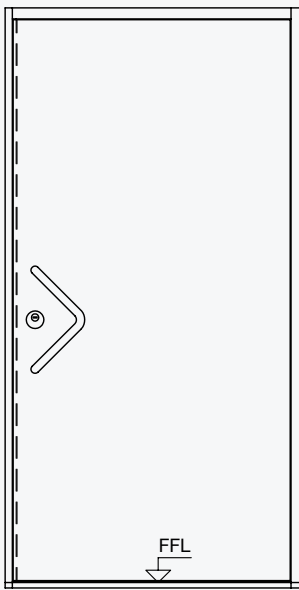

Single-leaf door

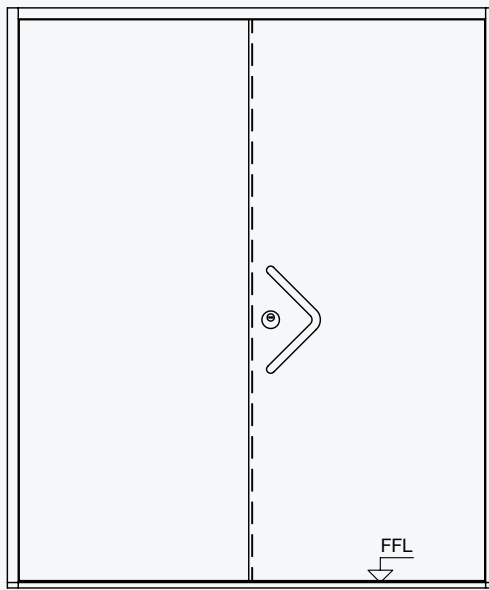

Double-leaf door

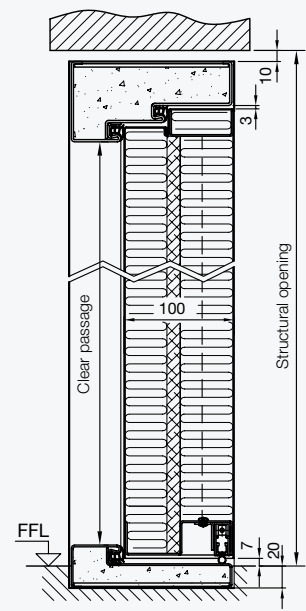

Vertical section

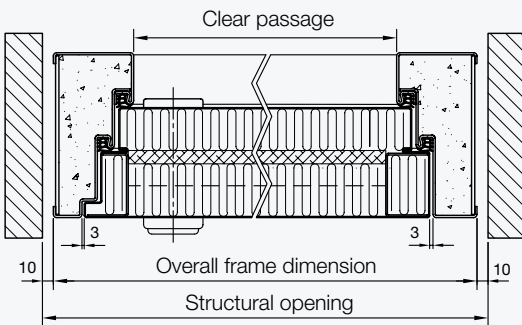

Horizontal section
Single-leaf door

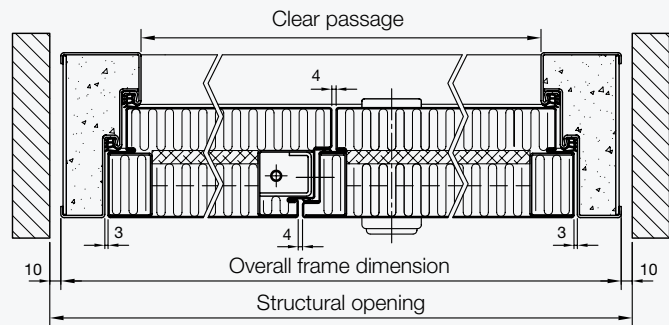

Horizontal section
Double-leaf door

Standard size range

	Structural opening order size width x height	Overall frame dimensions width x height	Clear passage width x height
Single-leaf door	1000 x 2200	980 x 2210	835 x 2098
	1000 x 2400	980 x 2410	835 x 2298
	1000 x 2500	980 x 2510	835 x 2398
	1100 x 2200	1080 x 2210	935 x 2098
	1100 x 2400	1080 x 2410	935 x 2298
	1100 x 2500	1080 x 2510	935 x 2398
	1200 x 2200	1180 x 2210	1035 x 2098
	1200 x 2400	1180 x 2410	1035 x 2298
1200 x 2500	1180 x 2510	1035 x 2398	
Double-leaf door	1500 x 2200	1480 x 2210	1335 x 2098
	1500 x 2400	1480 x 2410	1335 x 2298
	1500 x 2500	1780 x 2210	1335 x 2398
	1800 x 2200	1780 x 2410	1635 x 2098
	1800 x 2400	1780 x 2510	1635 x 2298
	1800 x 2500	1980 x 2210	1635 x 2398
	2000 x 2200	1980 x 2410	1835 x 2098
	2000 x 2400	1980 x 2390	1835 x 2298
2000 x 2500	1980 x 2510	1835 x 2398	

Opening direction

Single-leaf Door

Double-leaf Door

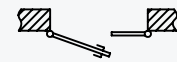

LH hinge

LH hinge

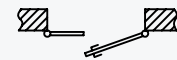

RH hinge

RH hinge

Steel top security door range size

Single-leaf Door

Double-leaf Door

Width 900 – 1400

Width 1400 – 2700

Height 1900 – 2700

Height 1900 – 2700

Unit: mm



Experience real Hörmann quality

For every application involving new construction and modernisation

Garage doors

Perfectly match your personal architectural style: up-and-over or sectional doors with colourful coatings or a Decograin surface.

Door operators

Enjoy extra convenience and security: Hörmann operators for garage doors and entrance gates.

Steel security doors

Hörmann provides you with safe and sturdy security doors in various grades. There will be one to fit your needs.

Steel doors

Sturdy doors for your entire home, from the basement to the roof.



www.hoermann.com

All rights reserved. No part may be reproduced without our prior permission. Subject to changes.

Hörmann: Quality without Compromise



Hörmann KG Amshausen, Germany



Hörmann KG Antriebstechnik, Germany



Hörmann KG Brandis, Germany



Hörmann KG Brockhagen, Germany



Hörmann KG Dissen, Germany



Hörmann KG Eckelhausen, Germany



Hörmann KG Freisen, Germany



Hörmann KG Ichttershausen, Germany



Hörmann KG Werne, Germany



Hörmann Genk NV, Belgium



Hörmann Alkmaar B.V., Netherlands



Hörmann Legnica Sp. z o.o., Poland



Hörmann Beijing, China



Hörmann Tianjin, China



Hörmann LLC, Montgomery IL, USA



Hörmann Flexon LLC, Burgettstown PA, USA

Hörmann is the only manufacturer worldwide that offers you a complete range of all major building products from one source. We manufacture in highly-specialized factories using the latest production technologies.

The comprehensive manufacturing, sales and service network in Europe, Asia and America makes Hörmann your strong international partner for the high-quality construction.

“Quality without Compromise”.

GARAGE DOORS
OPERATORS
DOORS
PARTITION WALLS
INDUSTRIAL DOORS
LOADING TECHNOLOGY

Copyright. No part of this brochure may be reproduced without our permission. Subject to changes.

Print: 01.2014 (Issue: 01.2014)
 Some of the doors shown in this brochure have special features and therefore do not always represent the standard version.

www.hoermann.com

